

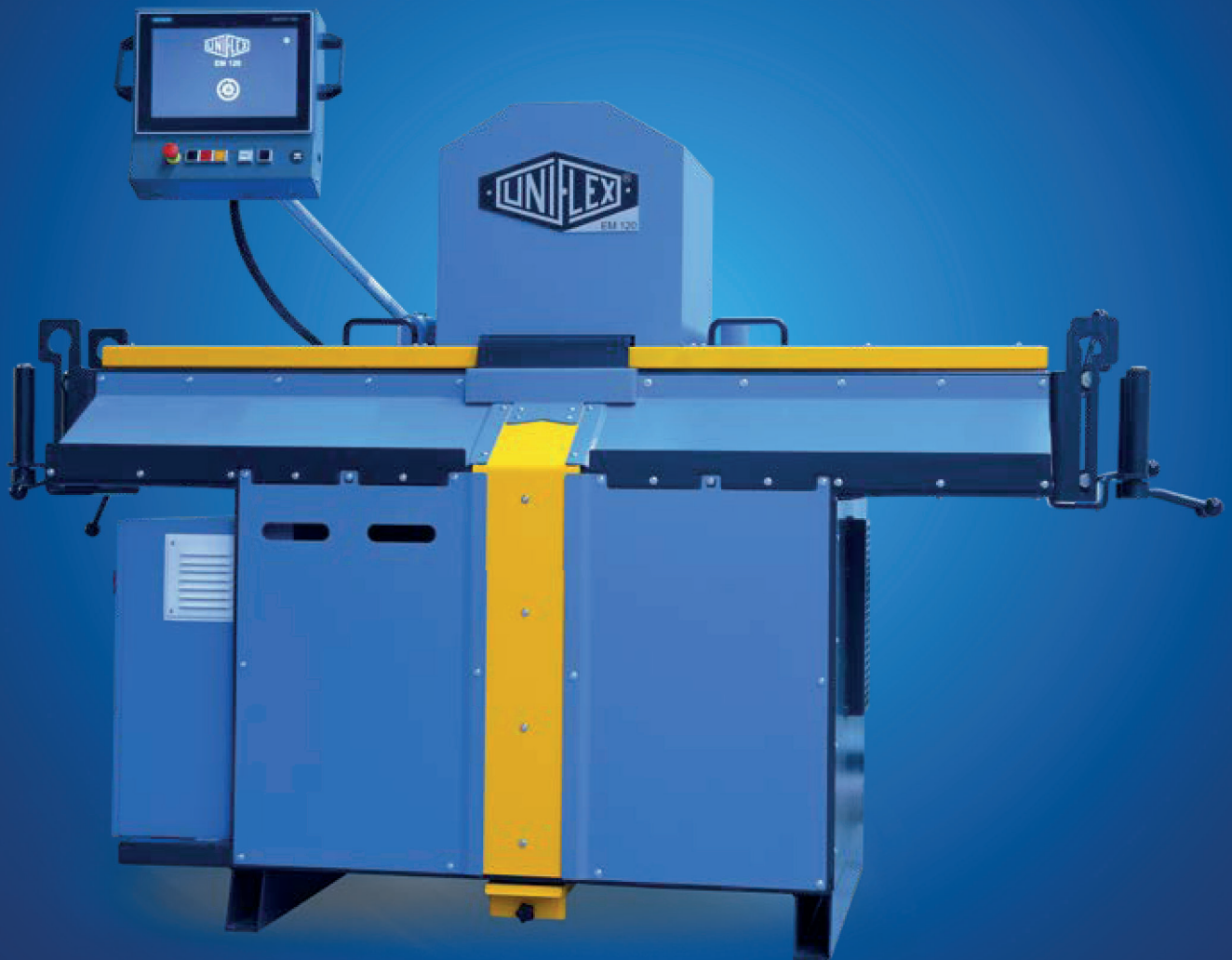

# Cutting Machines

Clean cutting, safe handling.



# Content



Page 55  
**Cutting Blades |  
Cutting Knives**



Page 56-57  
**EM 1 | EM 3**



Page 58-59  
**EM 4**



Page 60-61  
**EM 6 | EM 8**



Page 62-63  
**EM 115 | EM 120**



Page 64-65  
**EMI 150 | EMI 200**



Page 66  
**UPG 10**



Page 67  
**USC 10 | USC 20 |  
USC 30**



Page 68-69  
**UVC 25 FSD |  
UVC 50 FSD |  
UVC 100 FSD**



Page 70  
**Options and  
Accessories**



# Cutting Machines



## Universal

- For all types of hoses and fittings



## Ecoline

- Value driven solution for less frequent use



## Energy efficient

- Less energy consumption with the same performance



## Special Brake Motor

- A safety feature meeting DIN CE standards requiring the cutting blade to stop turning in 10 seconds

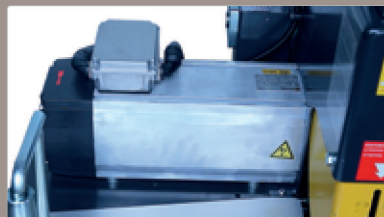

## Special Cutting Motor

- Higher forces are achieved using a bigger shaft

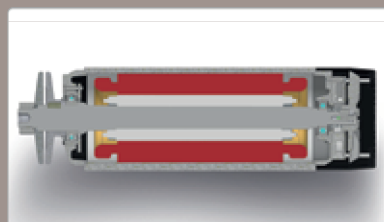

## Test-proven Cutting Blades

- Cutting blades are made out of test-proven material



## Environment friendly

- Engineered to last

### Cutting Blades – For all Cutting Machines



TM

TM G

TM C



### Cutting Knives – For UPG 10

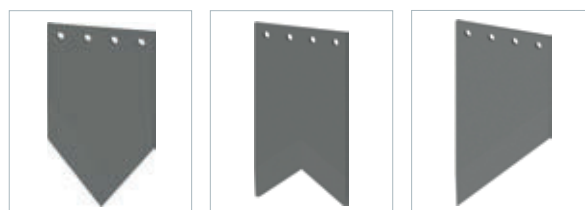

V-Shape

A-Shape

/-Shape



Technical Data	TM	TM G	TM C
Dirt	excellent	good	mid
Economy/costs	good	good	good
Durability	good	good	excellent
Resharpened	yes	yes	no
High wire rate	mid	good	excellent
High rubber rate	excellent	excellent	excellent
Heat resistance	mid	good	excellent
Features			
Hose suitability	Especially suitable for 2 wire hoses.	Especially suitable for 4 and 6 wire hoses.	Abrasive- suitable for 4- and 6-layer spiral hoses with a lot of steel and for clean cuts.

Technical Data	V-Shape	A-Shape	/-Shape
Hard hoses	✓	✓	✓
Profiles	✓	✓	✓
Band/belts	✓	✓	✓
Soft hoses	✓	✓	–
Thick wall thickness	–	✓	✓
Thin wall thickness	✓	–	✓
Features			
Hose suitability	334.001.3: V-shaped knife Universal knife, usable for most thin-walled industrial hose assemblies with/without plastic spiral. Not suitable for hoses with steel reinforcement.	334.033.3: V-shaped knife For very soft hose assemblies with thicker wall thickness, e.g. rubber hose assemblies. Not suitable for hoses with steel reinforcement.	334.034.4: \-shaped knife (sloping) For hose assemblies without spiral with thin to thick wall thickness. Prevents deformation of the hose line during cutting = very straight cut.



UNIFLEX hose cutting machines have been a synonym for the highest precision and robustness for many decades. The solid and compact tools distinguish themselves by their safe and high-quality cutting function. A distinct property is the positioning of the extraordinarily sharp cutting blades close to the powerful motors. This significantly reduces vibration – which is one of the reasons for extreme durability and low maintenance costs.



EM 3



EM 3 Ecoline

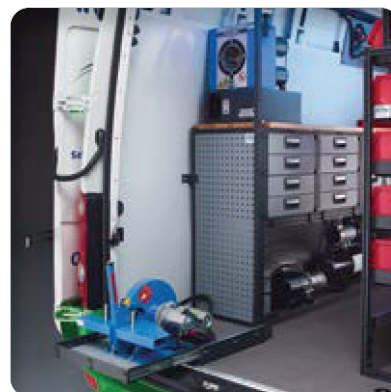

The DC machines are ideal for mobile use.

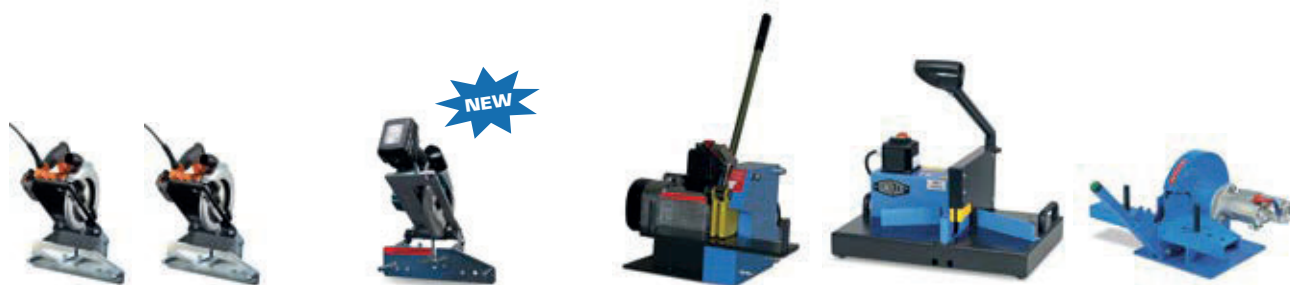

EM 1

EM 1 S



EM 1 SB



EM 3

EM 3 Ecoline

EM 3 DC

Technical Data	EM 1	EM 1 S	EM 1 SB	EM 3	EM 3 Ecoline	EM 3 DC
Production 4-spiral	-	-	-	¾"	-	-
Workshop 4/6-spiral	-	1"	1"	1¼"	1"	1¼"
4-spiral	⅝"	1¼"	1¼"	1¼"	1¼"	1¼"
Industrial	1¼"	1¼"	1¼"	2"	1¼"	2"
Max. outside (mm)	Ø 45	Ø 52	Ø 52	Ø 80	Ø 52	Ø 60
Noise level	90 dBA	90 dBA	90 dBA	80 dBA	95 dBA	93 dBA
Brake motor	-	-	-	✓	-	-
Suction connection (mm)	-	-	Ø 30	Ø 80	Ø 40	Ø 40
Drive	1.2 kW 1~VAC	1.2 kW 1~VAC	Battery	3 kW 1~VAC	1.8 kW 1~VAC	12 V/24 V 2.0/3.2 kW
Cutting blade (mm)	TM 190x2.0x30 TM 190x2.0x15,875	TM C 190x2x30	TM C 160x2.5x20	TM 275x3x30	TM G 200x1.6x25.4	TM 250x2x40Z
L x W x H (mm)	300 x 340 x 310	300 x 340 x 310	400 x 300 x 415	540 x 440 x 300	400 x 510 x 540	550 x 365 x 410
Weight (kg)	8	8	7,5	50	20	29
<b>Accessories</b>						
TU Table	✓	✓	✓	✓	✓	✓
Suction device *	-	-	✓	✓	✓	✓
UVC 25 Adapter	-	-	520.7010	520.7014	520.7010	520.7010
UVC 50 Adapter	-	-	518.7010	518.7014	518.7010	518.7010
Hose measuring tool UMS 4	-	-	-	✓	✓	-
Foot for UMS 4 (840 mm high)	-	-	-	✓	✓	-
Hose guide 2,000 mm (UHG 14)	-	-	-	✓	✓	-

\* Adapter needed.

Suction & filter device page 68 / Options and accessories page 70

## Description



Tested high-quality cutting blade, secured with a metal sheet.



Guide pins ensure straight cuts.

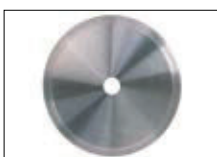

Blades  
TM = plain  
TM G = slotted  
TM C = coated



High-quality cutting blades:  
TM C, TM G und TM.



TM C  
Lasts 7 times longer, cuts twice as fast, generates less smoke, less debris in the hose and less heat.  
Reduces the risk of separation of the rubber from the wire.

## Cutting blades



UNIFLEX hose cutting machines have been a synonym for the highest precision and robustness for many decades. The solid and compact tools distinguish themselves by their safe and high-quality cutting function. A distinct property is the positioning of the extraordinarily sharp cutting blades close to the powerful motors. This significantly reduces vibration – which is one of the reasons for extreme durability and low maintenance costs.



EM 4



EM 4 DC



EM 4

EM 4 DC

Technical Data	EM 4	EM 4 DC
Production 4-spiral	1¼"	–
Workshop 4/6-spiral	1½"	1¼"
4-spiral	2"	1½"
Industrial	2"	2"
Max. outside (mm)	Ø 80	Ø 75
Noise level	80 dBA	93 dBA
Brake motor	✓	–
Suction connection (mm)	Ø 80	Ø 40
Drive	3 kW 1–VAC	2.0 kW 12VDC
Cutting blade (mm)	TM C 275 x 3 x 30	TM C 250 x 2 x 40
L x W x H (mm)	700 x 510 x 700	740 x 365 x 610
Weight (kg)	60	29
<b>Accessories</b>		
Bench	✓	✓
Suction device	✓	✓
UVC 25 Adapter	520.7014	520.7010
UVC 50 Adapter	518.7014	518.7010
Hose measuring tool UMS 4	✓	✓
Foot for UMS 4 (840 mm height)	✓	–
Hose guide 2000 mm (UHG 14)	✓	–

Suction & filter device page 68 / Options and accessories page 70

Description



Guide pins ensure straight cuts.



Blades  
TM = plain  
TM G = slotted  
TM C = coated

Cutting blades



High-quality cutting blades:  
TM C, TM G und TM.



TM C  
Lasts 7 times longer; cuts twice as fast, generates less smoke, less debris in the hose and less heat.  
Reduces the risk of separation of the rubber from the wire.



UNIFLEX hose cutting machines have been a synonym for the highest precision and robustness for many decades. The solid and compact tools distinguish themselves by their safe and high-quality cutting function. A distinct property is the positioning of the extraordinarily sharp cutting blades close to the powerful motors. This significantly reduces vibration – which is one of the reasons for extreme durability and low maintenance costs.



EM 6 M



EM 8 M



EM 8 P





EM 6 DC

EM 6 M

EM 6 P

EM 6 Ecoline



EM 8 M

EM 8 P

Technical Data	EM 6 DC	EM 6 M	EM 6 P	EM 6 Ecoline	EM 8 M	EM 8 P
Production 4-spiral	–	1¼"	1¼"	–	1½"	1½"
Workshop 4/6-spiral	2"	2"	2"	2"	2"	2"
4-spiral	2"	2"	2½"	2"	2½"	2½"
Industrial	2"	3"	3"	2"	4"	4"
Max. outside (mm)	Ø 75	Ø 95	Ø 95	Ø 80	Ø 120	Ø 120
Feed	manual	manual	pneumatic	manual	manual	pneumatic
Noise level	93 dBA	80 dBA	80 dBA	95 dBA	85 dBA	90 dBA
Brake motor	–	✓	✓	–	✓	✓
Suction connection (mm)	Ø 40	Ø 60	Ø 60	Ø 80	Ø 80	Ø 80
Drive	3.2 kW : 24 VDC	4.6 kW 3~VAC	4.6 kW 3~VAC	2.4 kW 1~VAC	4.6 kW 3~VAC	4.6 kW 3~VAC
Cutting blade (mm)	TM C 250 x 2 x 40	TM C 350 x 3 x 30	TM C 350 x 3 x 30	TM C 275 x 3 x 25,4	TM C 400 x 4 x 30	TM C 400 x 4 x 30
Integrated spark extinguisher	–	–	–	–	✓	✓
L x W x H (mm)	740 x 365 x 610	745 x 690 x 430	820 x 785 x 755	700 x 510 x 700	983 x 760 x 875	983 x 760 x 540
Weight (kg)	29	75	110	45	122	140
<b>Accessories</b>						
Bench	✓	✓	✓	✓	✓	✓
Suction device	✓	✓	✓	✓	✓	✓
UVC 25 Adapter	520.7010	520.7012	520.7012	520.7014	520.7014	520.7014
UVC 50 Adapter	518.7010	518.7012	518.7012	518.7014	518.7012	518.7012
Hose guide (UHG 14)	–	✓	✓	✓	✓	✓
Counter	–	329.1	Standard	–	323.1	323.1

Suction & filter device page 68 / Options and accessories page 70

## Description

## Cutting blades



Guide pins ensure straight cuts.



Blades  
TM = plain  
TM G = slotted  
TM C = coated



329.1 (for EM 6 M)  
323.1 (for EM 8)



High-quality cutting blades:  
TM C, TM G und TM.



TM C  
Lasts 7 times longer, cuts twice as fast, generates less smoke, less debris in the hose and less heat.  
Reduces the risk of separation of the rubber from the wire.



The EM 115 and EM 120 are highly productive cutting machines. These machines are best suited for high volume manufacturing of 2" hoses along with workshop capability for 3" high pressure hoses and 4" industrial hoses.

The UNIFLEX EM 120 is a hose-cutting machine for hydraulic and industrial hoses with outside diameters up to 135 mm. The EM 120 is the first fully electric cutting machine. The hose is pre-bent and clamped while the blade is moving up through the hose. Via IPC for Industry 4.0 or IoT, the operator just needs to type in the diameter and the machine sets itself and adapts the speed via sensors. This results in an optimized straight cut without tearing marks. UNIFLEX recommends the use of the suction and filter device UVC 100 or UVC 50 while using the EM 120.

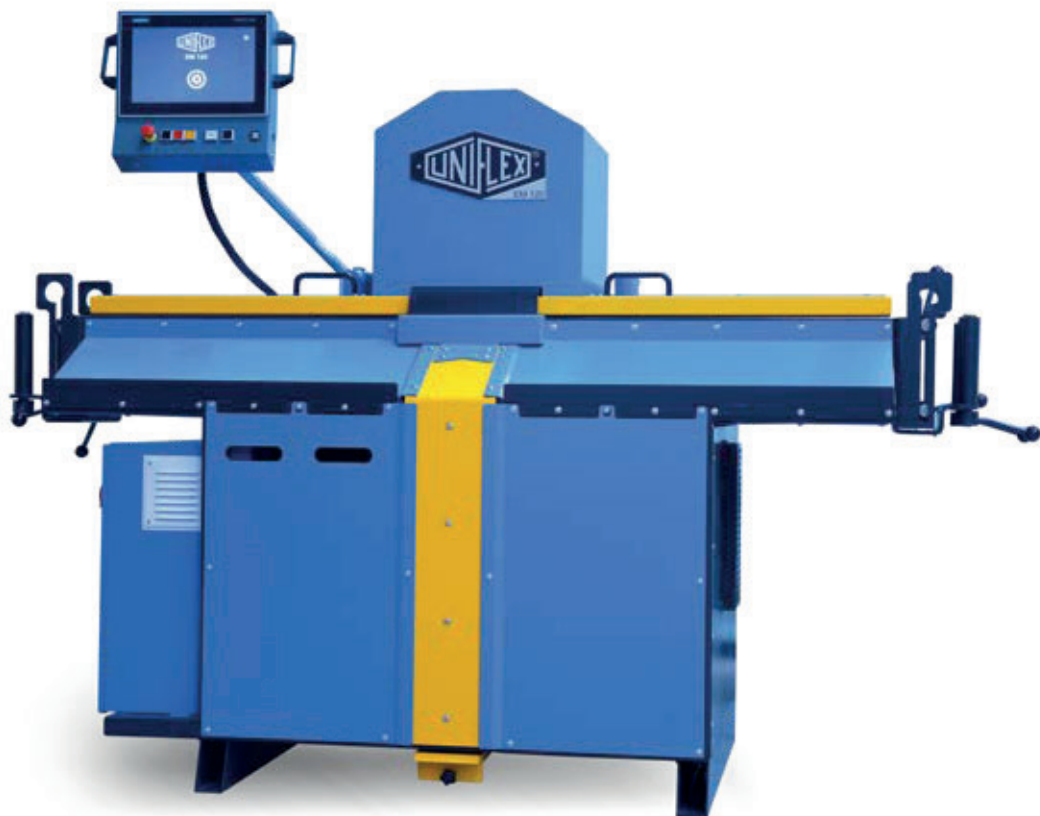

EM 120



EM 115



EM 115

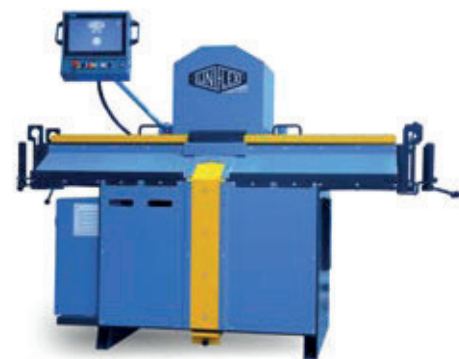

EM 120



Technical Data	EM 115	EM 120
Production 4/6-spiral	2"	3"
Workshop 4/6-spiral	3"	4"
Industrial	3"	4"
Max. outside (mm)	Ø 125	Ø 135
Feed	pneumatic	electric
Noise level	80 dBA	80 dBA
Brake motor	✓	✓
Suction connection (mm)	Ø 100	Ø 100
Drive	7.5 kW 3~VAC	7.5 kW 3~VAC
Cutting blade (mm)	TM C 520x4x40	TM C 520 x 4 x 40
L x W x H (mm)	1,210 x 650 x 1,650	2,024 x 1,025 x 1,600
Weight (kg)	245	350
<b>Options</b>		
Suction device	UVC 50 / UVC 100	UVC 50 / UVC 100
Hose guide (UHG 14)	✓	✓
UVC 50 Adapter	518.7016	518.7016
Laser	327.2220	–

Suction & filter device page 68 / Options and accessories page 70

## Description

## Cutting blades



Lateral guide rolls for guiding and positioning of the hose, for a better cutting quality (EM 115)



Various bending points selectable for straighter cuts and relief of pinch on the blade.



Exchangeable guide (two sizes) for optimum positioning of different hose sizes. (Only: EM 115)



Laser cutting line indicator 327.2220 – new upgrade kit for EM 115.



High-quality cutting blades: TM C, TM G und TM.



TM C  
Lasts 7 times longer, cuts twice as fast, generates less smoke, less debris in the hose and less heat.

Reduces the risk of separation of the rubber from the wire.



The new EMI 150 and EMI 200 industrial hose cutting machines from UNIFLEX are available for cutting of up to 6" hoses (EMI 150) and up to 8" hoses (EMI 200). Their compact dimensions and robust design make these cutting machines well suited for small workshops as well as bigger production areas. The machines have wheels, so they can easily be moved to the hose instead of carrying heavy hoses around the workshop. Both devices are equipped with the specially coated TM C cutting blade, which substantially reduces the force required and the wear during cutting.

Each machine comes with a 2-year warranty for the best return on investment.



EMI 150 / EMI 200



EMI 150 / EMI 200



EMI 150

EMI 200

Technical Data	EMI 150	EMI 200
Production 4/6-spiral	3"	3"
Industrial	6" non spiral hoses (5" spiral or concrete hoses)	8" non spiral hoses (6" spiral or concrete hoses)
Max. outside (mm)	Ø 195	Ø 250
Feed	manual	manual
Noise level	90 dBA	90 dBA
Brake motor	✓	✓
Suction connection (mm)	Ø 102	Ø 102
Drive	7.5 kW 3~VAC	7.5 kW 3~VAC
Cutting blade (mm)	TMC 520 x 4 x 40	TMC 600 x 6 x 40
L x W x H (mm)	1,000 x 1,140 x 1,460	1,070 x 1,620 x 1,570
Weight (kg)	215	240
<b>Options</b>		
Suction device	✓	✓
UVC 50 Adapter	518.7016	518.7016

Suction & filter device page 68 / Options and accessories page 70

## Cutting blades



High-quality cutting blades:  
TM C, TM G und TM.

**TM C**

Lasts 7 times longer, cuts twice as fast, generates less smoke, less debris in the hose and less heat.

Reduces the risk of separation of the rubber from the wire.

# UPG 10

Cutting thick industrial hoses like a hot knife through butter is not very easy, even if the hoses are not metal-reinforced. Therefore, UNIFLEX has developed a special cutting machine for extremely fast, simple and clean cuts of hoses up to a diameter of 2" with a pneumatically driven and razor-sharp guillotine. Safety and protection at the workplace and ergonomics are a matter of course for this UNIFLEX machine – as is the 2-year manufacturer's warranty.

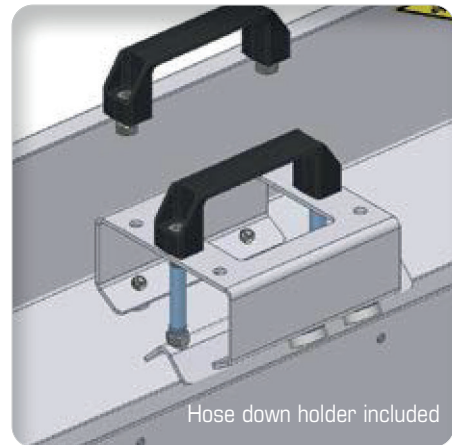

## UPG 10

Technical Data	UPG 10
Guillotine for industrial hoses without steel wire	up to 3" (max. OD: 90 mm/3.45")
L x W x H (mm)	1,810 x 325 x 800
Weight (kg)	56
Noise level	70 dBA
Air pressure	7 bar
Minimum cut length	20 mm (0.78")

## Description



334.001.3: V-shaped knife.  
Standard blade for the UPG 10

Universal knife, usable for most thin-walled industrial hose assemblies with/without plastic spiral. Not suitable for hoses with steel reinforcement.



334.033.4: A-shaped knife.  
Accessories UPG 10.

For very soft hose assemblies with thicker wall thickness, e.g. rubber hose assemblies. Not suitable for hoses with steel reinforcement.



334.034.4: \-shaped knife (sloping).  
Accessory UPG 10.

For hose assemblies without spiral with thin to thick wall thickness. Prevents deformation of the hose line during cutting = very straight cut. Not suitable for hoses with steel reinforcement.

# Planetary cutting machines USC 10 | USC 20 | USC 30

The USC 10, USC 20 and USC 30 from UNIFLEX are unique planetary cutting machines designed to cut corrugated metal and PTFE hoses. With the new accessory 325.7, the machines can now even cut hoses with a diameter as small as 6 mm without flaring! Without the accessory, the minimum cutting depth was 10 mm. The USC 10 thus guarantees perfect results along an extended size spectrum (up to 51 mm): virtually scrap-free cutting without reworking, highly efficient as the hoses are instantly ready for further machining such as crimping or welding.



USC 10 | USC 20 | USC 30

Technical Data	USC 10	USC 20	USC 30
Cutting blade (mm)	TM PC 200 x 2 x 25.4	TM PC 250 x 2 x 25.4	TM PC 350 x 3 x 32
Wire braid	0 - 2"	2" - 4"	4" - 6"
Hose diameter (mm)	Ø 3/8" - 2" (DN 10-51)	Ø 2" - 4" (DN 50-100)	Ø 4" - 6" (DN 100-150)
Max. Outer diameter (mm)	Ø 0.4" - 2.6" (OD 10-68)	Ø 2.3" - 5.1" (OD 60-130)	Ø 5" - 7.8" (OD 128-200)
Max. rotation wire forming blade	7,200 rpm	7,200 rpm	4,100 rpm
Max. rotation trimming	60 rpm	60 rpm	30 rpm
Drive	4.6 kW 3~VAC	4.6 kW 3~VAC	5 kW 3~VAC
Air pressure	6 bar	6 bar	6 bar
Noise level	85 dBA	85 dBA	85 dBA
Working high (mm)	1,020	1,100	1,045
L x W x H (mm)	730 x 670 x 1,400	730 x 770 x 1,500	900 x 1,250 x 1,520
Weight (kg)	245	340	580
Control Siemens S7	✓	✓	✓
Article memory	✓	✓	✓
Feed	pneumatic	pneumatic	pneumatic
Suction device	Standard	Standard	Standard
<b>Options</b>			
Hose guide (UHG 14)	✓	✓	✓

## Description



Bad



Bad

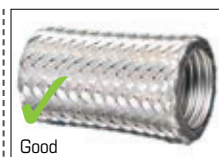

Good



Good

Conventional machine

USC

**Planetary cutting machine** for corrugated metal hoses and PTFE hoses.

The unique procedure enables quick and neat cutting of corrugated metal and PTFE hoses without flaring the other stainless steel braid.

- Eliminates flaring
- No more trimming
- Easily slip the ferrule into position
- Reduces assembly injuries
- Improves production efficiency
- Touch panel with memory (optional 5.7" display)
- Quick and easy set up
- Allows broader application range to now include PFTE hose



UNIFLEX hose cutting machines ensure precise cuts - but the unavoidable generation of dust, fumes and odors requires an effective solution. For workshops, UNIFLEX offers the compact UVC 25, a new single-phase extraction unit that is ideal for small workshops and mobile applications. For larger requirements, the UVC 50 is available as a workbench version, while the UVC 100 was developed for series production and can operate up to three hose cutting machines. All models work with multi-stage exhaust air purification, including spark extinguishing, cyclone and particle filters, activated carbon and HEPA technology for odor neutralization - all with a 2-year manufacturer's warranty from UNIFLEX.



UVC 100 FSD



UVC 50 FSD



UVC 25 FSD





UVC 25 FSD



UVC 50 FSD



UVC 100 FSD

Technical Data	UVC 25 FSD	UVC 50 FSD	UVC 100 FSD
Max. volume flow	100 m³/h	400 m³/h	1,280 m³/h
Fan performance	1,320 m³/h	700 m³/h	1,440 m³/h
Max. vacuum	2,100 Pa	4,400 Pa	5,300 Pa
Main-filter surface	2.5 m²	5 m²	10 m²
Drive power	0.95 kW	3.0 kW	3.0 kW
Drive	220-240 Multivoltage	220-240 V / 380-415 V / 440-460 V	220-240 V / 380-415 V / 440-460 V
Intake diameter (mm)	Ø80 *	Ø80 *	Ø100 - Ø160 (Ø160 recommended) **
Dust collection container	2.5 l	10 l	12 l
Noise level	60 dBA	70 dBA	70 dBA
L x W x H (mm)	600 x 570 x 555	1,180 x 730 x 820	950 x 950 x 2,060
Weight (kg)	60	215	560
<b>Accessories</b>			
Wheels	✓	779.2	✓

\* Delivered without adapter

\*\* Delivered with 3 adapters 160 mm, 125 mm and 100 mm

## Filter Principle

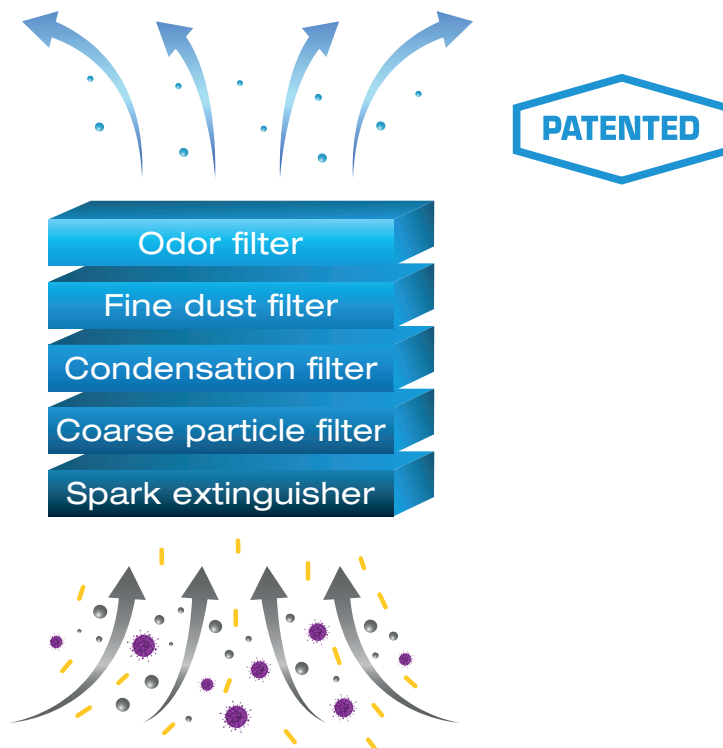

# Options and Accessories – For Cutting Machines

Item number + Description		Item number + Description	
<p><b>UWT 2 vs (optional UMS 4 + 514.1)</b> Electric driven hose coiling reel with foot pedal for easy winding and unwinding of hoses up to 1¼" optional with length measuring device incl. foot stand. RPM per Pedal: 0 to 61 RPM mandrel adjustment (mm): min. Ø 330 max. Ø 730 Maximum Load (kg): 80 L x W x H (mm): 800 x 900 x 1600 Weight (kg): 70 Clamping diameter (mm): Ø330-730</p>		<p><b>UMS 4 + 514.1 (floor stand)</b> Hose measuring tool up to 1¼", Ø1 OD Ø 65 mm can be mounted in front of the cutter or on a hose coiler. Measures up to (m): 999,99 Tolerance (%): 2 - 7 L x W x H (mm): 250 x 260 x 120 Weight (kg): 5 Metric unit only</p>	
<p><b>UHG 14 + UHG 14 ext</b> UHG 14 Hose guide 2000 mm and UHG 14 ext. extension guide 1000 mm for all cutting machines Hose up to 110 mm outer Ø and DN 75 3 inch.</p>		<p><b>329.1 (for EM 6 M) 323.1 (for EM 8)</b> Resettable cutting counter</p>	
<p><b>UAT 4</b> Hose winder for storing and unwinding hoses. Ø 1200 mm L x W x H (mm): 1200 x 1200 x 1301 Max. load (kg): 80 Weight (kg): 70 Center pin set up Minimum: Ø 277,5 Maximum: Ø 577,5</p> 		<p><b>UAT 10</b> Hose winder for storing and unwinding hoses. Ø 1500 mm L x W x H (mm): 1300 x 1500 x 1280 Max. load (kg): 250 Weight (kg): 130 Center pin set up Minimum Ø: 277,5 Maximum Ø: 577,5</p> 	
<p><b>USH 4-5</b> Hose winder for the easy storage of your hydraulic hoses, up to seven levels. Cage-Ø outside/inside (mm): 820/760 External dimension (mm): 1000 Level high (mm): 310 Cage ultimate load (kg): 80</p>		<p><b>URU 2</b> URU 2 with accessories roller kit 408.2 Max. width (mm): 500 Max. Ø (mm): 85-1000 Load capacity (kg): 240</p> 	
<p><b>513.1</b> Plate with fixing bolts USH 4-5 Height (mm): 1650</p>		<p><b>513.1 (Accessories)</b> Plate for USH 4</p>	
<p><b>TU</b> Workbench for miscellaneous machines (84 x 71 x 75 cm) Max. load (kg): 800</p>		<p><b>TU 4 Ecoline</b> Workbench for miscellaneous machines (52 x 85 x 75 cm) Max. load (kg): 200</p> 	<p>Content not included in the scope of delivery</p> 
<p><b>778.2</b> Wheel option for TU und TU 4 Ecoline.</p>			